

PROFESSIONELLE Bestelwageninrichtung

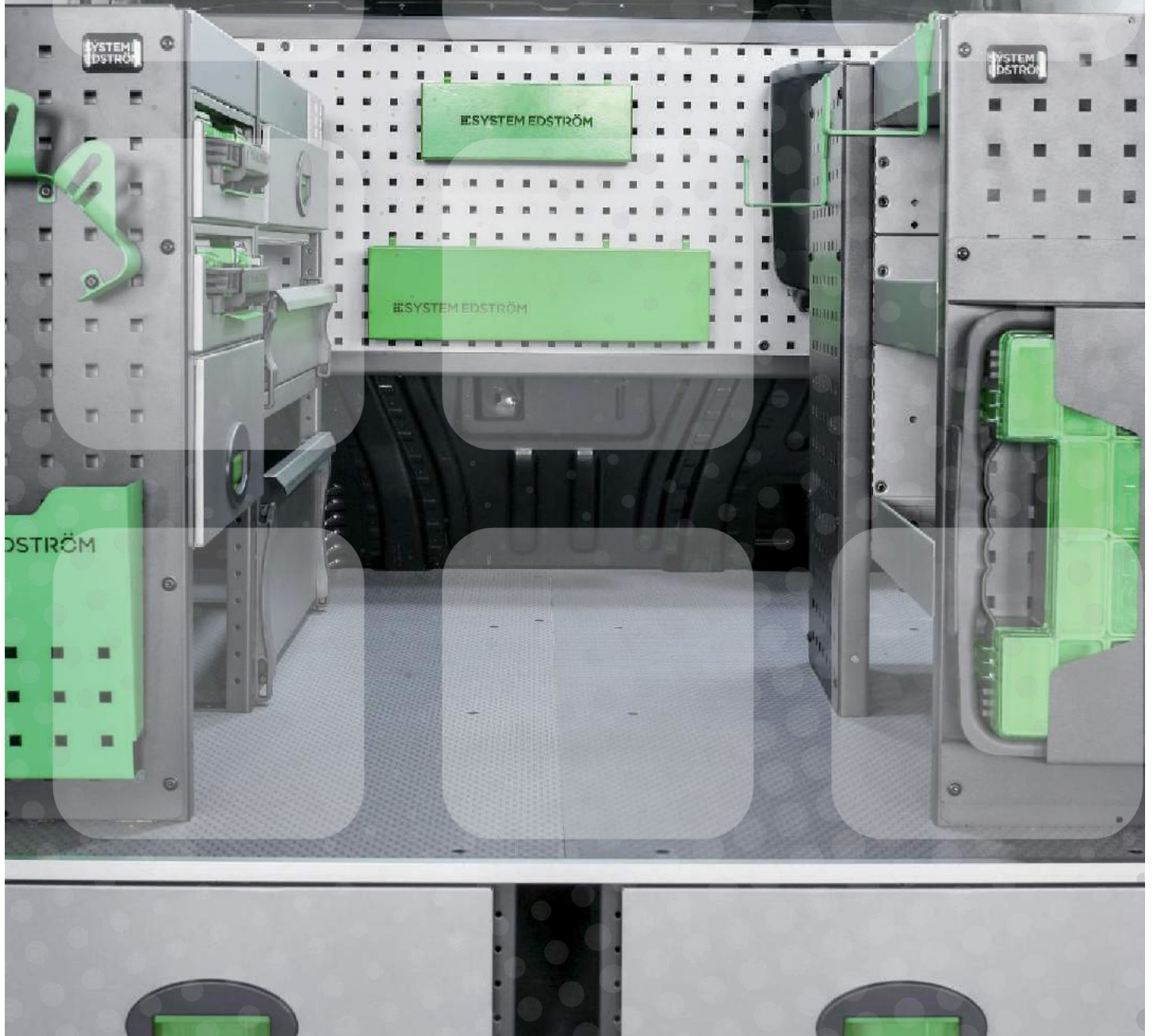

Metal Rack
Storage Solutions

SYSTEM 
EDSTRÖM



CREËERT MOBIELE WERKPLEKKEN

Wij passen de verkoopvoorwaarden toe volgens LCV14.



FLEXIBEL
GECRASHTEST
ZWEEDSE MAKELIJ
5 JAAR GARANTIE
MEER WAAR VOOR UW GELD
MEER DAN 60 JAAR ERVARING

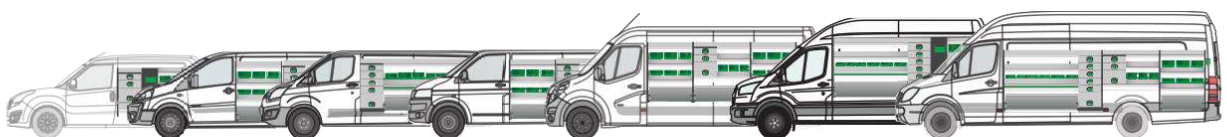



2005 & 2007

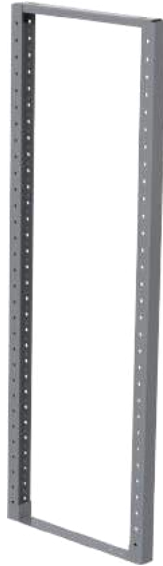

Frame

Diepte	Breedte	Hoogte	Kg	Art.Nr
300	31	505	1,6	2000
300	31	670	2,0	2002
300	31	890	2,5	2004
300	31	505/890	2,2	2005
300	31	1000	2,8	2006
300	31	670/1000	3,1	2007
300	31	1220	3,5	2008
300	31	1440	4,3	2010
470	31	505	1,9	2012
470	31	670	2,3	2014
470	31	825	2,6	2016
470	31	890	2,8	2018
470	31	1000	3,0	2020
470	31	1220	3,9	2022
470	31	1440	4,7	2024



Frame voor valse vloer en uitschuifbare legborden

Diepte	Breedte	Hoogte	Kg	Art.Nr
300	31	360	1,4	2070
300	31	190	1,0	2071
470	31	360	1,8	2072
470	31	190	1,4	2073



Frame opzetstuk

Diepte	Breedte	Hoogte	Diepte top	Kg	Art.Nr
300	31	185	160	1,0	2050
300	31	230	160	1,1	2052
300	31	290	160	1,2	2054
300	31	400	160	1,5	2056
470	31	185	300	1,3	2058
470	31	230	300	1,4	2060
470	31	290	300	1,6	2062
470	31	400	300	1,8	2064

Het frame opzetstuk wordt geplaatst aan de bovenzijde van het frame, waarna het wordt vastgezet met bout en moer.



Voetsteun voor frame

Min. H	Max. H	Hoogte	Kg	Art.Nr
10	400	500	0,6	2090

De voetsteun voor het frame kan worden gebruikt bij oneffenheden in het voertuig zoals bvb de wielkast. Aanpasbaar van 10 tot 400 mm.

Laden



Diepte	Breedte	Hoogte	Kg	Art.Nr
300	302	110	3,4	2331
300	302	220	4,8	2332
300	392	110	3,8	2341
300	392	220	5,4	2342
300	392	165	4,6	2343
300	605	110	4,9	2361
300	605	220	7,2	2362
300	784	110	5,7	2371
300	784	220	7,2	2372
470	302	110	4,7	2431
470	302	220	6,5	2432
470	392	110	5,2	2441
470	392	220	7,2	2442
470	392	165	6,3	2443
470	605	110	6,4	2461
470	605	220	9,1	2462
470	784	110	7,8	2471
470	784	220	10,9	2472

Bovenplaten



Diepte	Breedte	Hoogte	Kg	Art.Nr
300	302	1	0,7	2533
300	392	1	0,9	2534
300	605	1	1,5	2536
470	302	1	1,1	2543
470	392	1	1,5	2544
470	605	1	2,3	2546

Sokkels

Diepte	Breedte	Hoogte	Kg	Art.Nr
300	302	55	0,7	2633
300	392	55	0,8	2634
300	605	55	1,1	2636
470	302	55	0,9	2643
470	392	55	1,0	2644
470	392	120	2,0	2645
470	605	55	2,3	2646

Ladesysteem



Uitschuifbare legborden



Diepte	Breedte	Hoogte	Geschikt	Kg	Art.Nr
268	826	110	784 mm	7,4	1881
268	826	165	784 mm	8,0	1897
268	1035	110	997 mm	8,8	1882
268	1035	165	997 mm	9,6	1898
268	1218	110	1176 mm	10,1	1883
268	1218	165	1176 mm	10,9	1899
438	826	110	784 mm	8,9	1884
438	826	165	784 mm	9,9	1885
438	826	360	784 mm	12,7	1894
438	1035	110	997 mm	10,6	1886
438	1035	165	997 mm	11,7	1887
438	1035	220	997 mm	13,1	1888
438	1035	360	997 mm	15,1	1895
438	1218	110	1176 mm	11,9	1889
438	1218	165	1176 mm	13,3	1890
438	1218	220	1176 mm	14,8	1891
438	1218	360	1176 mm	17,2	1896

Tussenschotten voor uitschuifbare legborden



Diepte	Hoogte	Information	Kg	Art.Nr
-	-	Steunen, per set van 2	0,0	2753
436	62		0,4	2736
436	114		0,6	2738

2736 past 1884 - 1891.
2738 past 1885, 1887, 1888, 1890 & 1891.

Verdeelbakjes voor in laden



Diepte	Breedte	Hoogte	Kg	Art.Nr
300	127	70	0,2	3001
300	172	70	0,3	3003
470	127	70	0,4	3005
470	172	70	0,4	3007

Verdeelbakjes voor in laden, compleet met onderverdelingen, kunnen in laden en legborden gebruikt worden.

Gids voor indeling lade

Breedte lade	Bakje, aantal	Breedte lade	Bakje, aantal
302 mm	127 mm, 2 st	605 mm	127 mm, 3 st + 172 mm 1 st
392 mm	172 mm, 2 st	784 mm	127 mm, 3 st + 172 mm, 2 st

Lade mousse



Past in	Dikte	Kg	Art.Nr
2331 & 2332	3	0,0	5233
2341, 2342 & 2343	3	0,0	5234
2361 & 2362	3	0,0	5236
2371 & 2372	3	0,0	5237
2431 & 2432	3	0,0	5243
2441, 2442 & 2443	3	0,0	5244
2461 & 2462	3	0,0	5246
2471 & 2472	3	0,0	5247

Door uw lade van een mousse te voorzien, zal uw materiaal minder geluid maken tijdens het rijden.

Legborden



Diepte	Breedte	Rubber mat	Kg	Art.Nr
300	302	6600	1,4	1600
300	392	6602	1,7	1602
300	605	6604	2,5	1604
300	694	6606	2,7	1606
300	784	6608	3,0	1608
300	907	6610	3,5	1610
300	997	6612	3,7	1612
300	1086	6614	4,0	1614
300	1176	6616	4,3	1616
300	1210	6618	4,4	1618
300	1299	6620	4,8	1620
300	1389	6622	5,0	1622
300	1512	6624	5,4	1624
300	1568	6626	5,6	1626
300	1960	6632	9,5	1632
470	302	6700	2,0	1700
470	392	6702	2,4	1702
470	605	6704	3,4	1704
470	694	6706	3,8	1706
470	784	6708	4,2	1708
470	907	6710	4,8	1710
470	997	6712	5,2	1712
470	1086	6714	5,6	1714
470	1176	6716	6,1	1716
470	1210	6718	6,1	1718
470	1299	6720	6,5	1720
470	1389	6722	6,9	1722
470	1512	6724	7,5	1724
470	1568	6726	8,0	1726
470	1960	6799 (lm)	13,0	1730
160	997	6802	2,5	1802
160	1176	6804	2,9	1804
160	1568	6806	3,8	1806
160	1160-2120	6599 (lm)	5,5	1810
160	1830-3460	6599 (lm)	11,8	1812

Laadvermogen, gelijkmatig verdeelde belasting.
 Legbordbreedte 300 - 1600 mm 70 kg.
 Legbordbreedte 1601 - 1960 mm 50 kg.
 Verstelbare breedte 30 kg.

Legbordverbinder

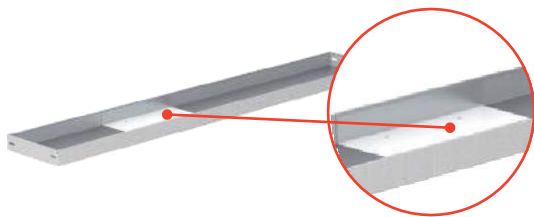

Diepte	Kg	Art.Nr
300	1,3	1834

Wij hebben een groot aanbod aan lengtes in legborden. Door middel van de legbordverbinder kan u met 2 legborden een specifiek gewenste lengte bekomen. (enkel legborden van 300 mm diep)

Tussenschotten

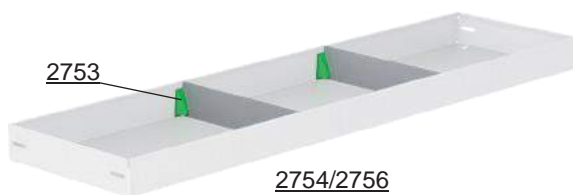

Diepte	Hoogte	Informatie	Kg	Art.Nr
-	110	Steunen, per set van 2	0,0	2753
300	110		0,2	2754
470	110		0,2	2756

Neerklapbare front



Diepte	Kg	Art.Nr
160	0,3	1831
300	0,5	1833

Legbord met open voorzijde



Diepte	Breedte	Rubber mat	Kg	Art.Nr
300	605	6604	2,6	3604
300	784	6608	3,2	3608
300	907	6610	3,5	3610
300	997	6612	4,0	3612
300	1176	6616	4,5	3616
470	605	6704	3,7	3704
470	784	6708	4,5	3708
470	907	6710	5,0	3710
470	997	6712	5,5	3712
470	1176	6716	6,3	3716

Laadvermogen: 70 kg gelijkmatig verdeelde belasting per legbord.

De legborden worden geleverd inclusief 8 stuks M6 zelftappers voor montage.

Neerklapbaar front

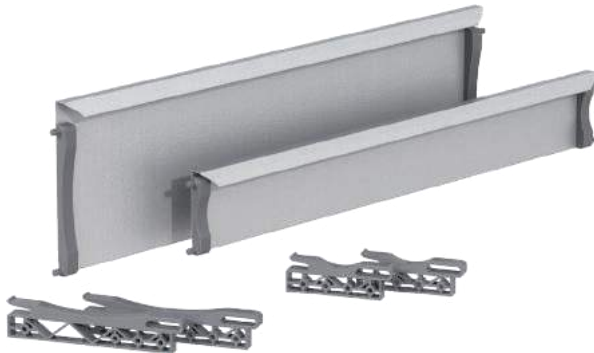

Diepte	Breedte	Hoogte	Kg	Art.Nr
38	605	110	0,9	3804
38	605	220	1,5	3805
38	784	110	1,2	3808
38	784	220	1,9	3809
38	907	110	1,3	3810
38	907	220	2,0	3811
38	997	110	1,4	3812
38	997	220	2,3	3813
38	1176	110	1,7	3816
38	1176	220	2,7	3817

Neerklapbare fronten worden compleet geleverd met de kunststof steunen.

Tussenschot voor legbord met open voorzijde



Diepte	Hoogte	Kg	Art.Nr
300	110	0,3	1990
300	220	0,5	1992
470	110	0,4	1994
470	220	0,8	1996

Legbord voor kabelrollen



Diepte	Breedte	Hoogte	Kg	Art.Nr
300	784	114	3,0	1688
300	Tussenschot	100	0,2	1689

Laadvermogen: 30 kg gelijkmatig verdeelde belasting.

Een verplaatsbaar tussenschot is inbegrepen.



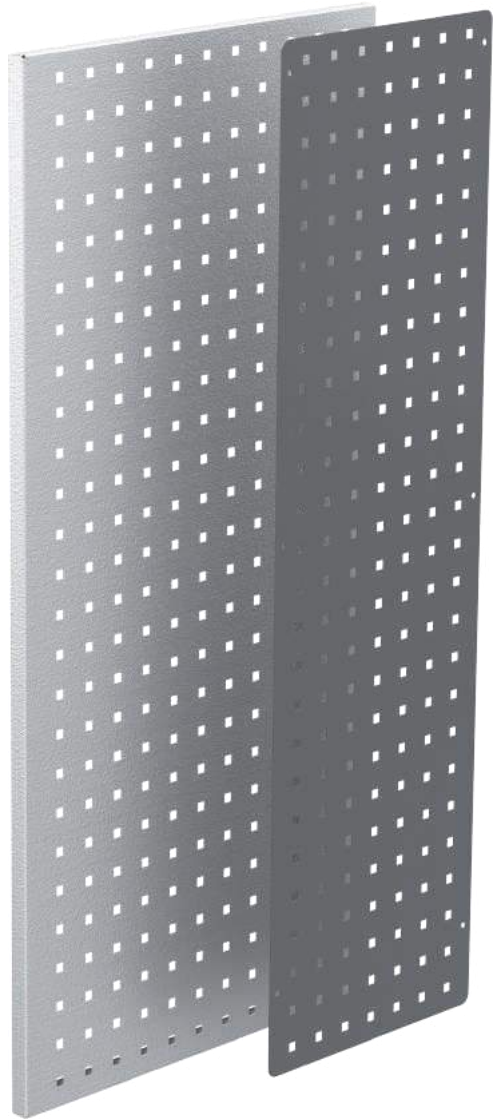

Perfopanelen - vlakke plaat

Diepte	Dikte	Hoogte	Kg	Art.Nr
300	1	505	0,8	2100
300	1	670	1,0	2102
300	1	890	1,4	2104
300	1	1000	1,5	2106
300	1	1220	1,9	2108
300	1	1440	2,2	2110
470	1	505	1,5	2120
470	1	670	2,0	2122
470	1	890	2,7	2124
470	1	1000	3,0	2126
470	1	1220	3,7	2128
470	1	1440	4,4	2130

Alle perfopanelen zijn voorzien van vierkant gestanste gaten, 10x10 mm en 37 mm center tot center.

Perfopanelen - randen omgezet

Diepte	Dikte	Hoogte	Kg	Art.Nr
300	20	890	2,4	2150
300	20	1000	2,7	2152
300	20	1220	3,3	2154
392	20	890	3,0	2155
470	20	890	3,6	2156
470	20	1000	4,0	2158
470	20	1220	4,8	2160
500	20	1500	6,1	2162
700	20	900	5,2	2164
700	20	1250	6,7	2166
700	20	1480	8,3	2168
-	-	-	-	-



Afstandbus

Art.Nr
3031

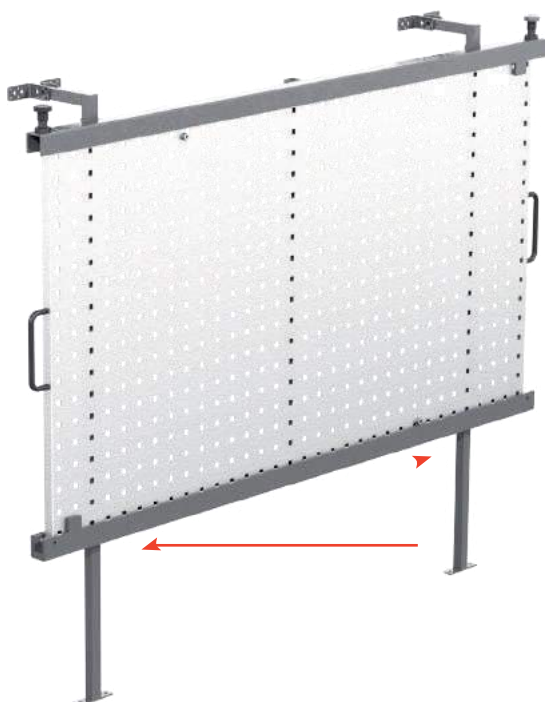

Uitschuifbaar perfo paneel

Diepte	Breedte	Hoogte	Kg	Art.Nr
230	1250	700	25,0	T7800
230	1480	700	16,0	T7801
230	1220	470	12,5	T7803

Het uitschuifbaar perfo paneel is uitschuifbaar in twee richtingen. Draagvermogen 125 kg. De totale hoogte is aanpasbaar door de voeten en steunen bovenaan om in elk voertuig te passen.



5204



Rubber mat

Diepte	Breedte	Kg	Art.Nr
1400	*	5,6	5204
160	*	0,2	6599
160	992	0,0	6802
160	1172	0,0	6804
160	1564	0,0	6806
298	298	0,1	6600
298	388	0,2	6602
298	600	0,3	6604
298	690	0,3	6606
298	780	0,4	6608
298	902	0,4	6610
298	992	0,4	6612
298	1082	0,4	6614
298	1172	0,5	6616
298	1204	0,5	6618
298	1295	0,6	6620
298	1384	0,6	6622
298	1506	0,6	6624
298	1564	0,6	6626
298	1956	0,8	6632
298	*	0,4	6699
468	298	0,2	6700
468	388	0,3	6702
468	598	0,4	6704
468	690	0,0	6706
468	780	0,6	6708
468	902	0,7	6710
468	992	0,7	6712
468	1082	0,0	6714
468	1172	0,8	6716
468	1204	0,0	6718
468	1294	0,0	6720
468	1384	0,9	6722
468	1506	0,0	6724
468	1564	1,1	6726
468	*	0,8	6799

Onze rubber matten zijn 1mm dik en hebben een gladde oppervlakte. Onze vloermat (art.nr. 5204 is geribbeld en versterkt.
*Verkocht per lopende meter (1 rol is 10meter)

Rubber mat voor uitschuifbare legborden



Past in	Kg	Art.Nr
1881 & 1897	0,3	6808
1882 & 1898	0,4	6812
1883 & 1899	0,4	6816
1884, 1885 & 1894	0,4	6908
1886, 1887, 1888 & 1895	0,6	6912
1889, 1890, 1891 & 1896	0,7	6916



Plastieken sorteerbakken



Diepte	Breedte	Hoogte	Kg	Art.Nr	€
300	121	145	0,3	3010	5,00
300	170	145	0,3	3012	6,25
300	291	1445	0,4	3017	11,50
470	121	145	0,4	3014	7,00
470	170	145	0,4	3016	8,50
470	291	145	0,6	3018	15,75

Gids voor plastieken sorteerbakken

Breedte van legbord	Aantal bakken		
	291 mm	170 mm	121 mm
302 mm		1	1
392 mm		2	
605 mm	1	1	1
694 mm		4	
784 mm	1	2	1
907 mm	2	1	1
997 mm	1	4	
1086 mm	1	3	2
1176 mm	2	2	2
1210 mm	1	3	3
1299 mm	2	2	3
1389 mm	2	4	1
1512 mm	2	4	2
1568 mm	2	5	1
1960 mm	2	8	





Uitschuifbare laadvloer

Diepte	Breedte	Kg	Art.Nr
1500	950	34,6	T7709
Tussenschot, universeel		0,0	T8393
Laadvermogen: 190 kg.			



8550



8560 - 8566



Verstelbaar frame

Breedte		Lengte		Kg	Art.Nr
Min	Max	Min	Max		
623	1234	950	1494	8,2	8550

Chassis van uitschuifbaar platform

Diepte	Breedte	Hoogte	Kg	Art.Nr
950	350	75	15,5	8560
1300	350	75	21,0	8561
1650	350	75	26,0	8562
950	700	75	20,9	8565
1300	700	75	28,0	8563
1650	700	75	35,0	8566

Alle platforms zijn uitschuifbaar tot twee derden van hun eigen lengte.
Het laadvermogen is 200 kg gelijkmatig verspreid.





Wielbakkasten

Diepte	Breedte	Hoogte	Kg	Art.Nr
300	998	330	12,0	2760
300	1176	330	13,5	2762
300	1210	330	13,6	2764
470	998	330	14,1	2766
470	1176	330	15,4	2768
470	1210	330	15,6	2770



Kasten

Diepte	Breedte	Hoogte	Kg	Art.Nr
470	392	770	19,5	2780
300	302	1155	12,8	2782
470	392	1155	18,7	2784

Deur links of rechts openend, uw keuze!
2782 is inclusief twee haken, 2784 bevat twee haken en een staaf.



Opberg box

Diepte	Breedte	Hoogte	Kg	Art.Nr
373	197	385	6,7	2920



Gereedschapscompartiment

Diepte	Breedte	Hoogte	Kg	Art.Nr
1500	250	300	23,0	5034
1700	250	300	25,0	5035



Gasfles kasten

Diepte	Breedte	Hoogte	Kg	Art.Nr
470	392	605	18,5	2918

Onze gasfles kast met deur incl. slot is uitgerust met houders voor 1 of 2 gasflessen, een uitneembaar legbord en ventilatie pijp. De deur kan links of rechts opengaan.

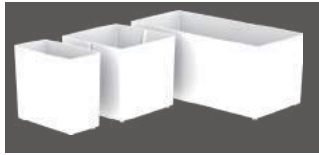

Koffer

Diepte	Breedte	Hoogte	Kg	Art.Nr
297	354	82	1,6	6302

Deze wordt geleverd met een mix van kleine bakjes. Bijkomende bakjes kunnen afzonderlijk aangekocht worden.

Kofferindeling

Diepte	Breedte	Hoogte	Kg	Art.Nr
40	77	68	0,0	6317
81	77	68	0,0	6318
163	77	68	0,1	6319



Koffer compartiment

Diepte	Breedte	Hoogte	Kg	Art.Nr
300	392	110	2,5	6300

Door de modulekoffer in een compartiment op te bergen kan u deze toevoegen in een rij lades.



Vaste steun voor koffer

Diepte	Kg	Art.Nr
300	0,5	6305
470	0,7	6306

De modulekoffer kan ook geplaatst worden op 2 vaste steunen. De koffer glijdt op de vaste steunen en wordt geblokkeerd door een opstaande lip vooraan.



Vaste steun voor koffer

Diepte	Breedte	Hoogte	Kg	Art.Nr
86	565	295	1,4	6307

Deze steun is in de eerste plaats ontworpen om op onze frames te passen. De houder kan gedraaid worden zodat deze zowel op 300 als 470 mm diep past.

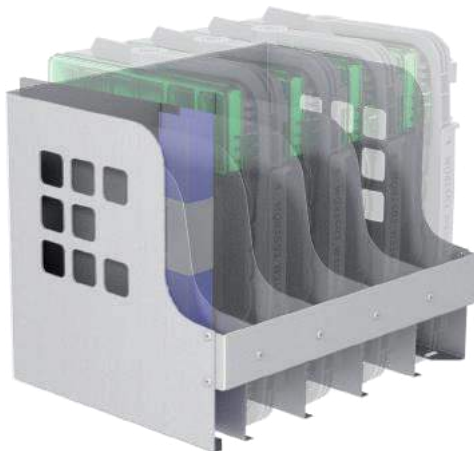

Koffer/Document houder

Diepte	Breedte	Hoogte	Kg	Art.Nr
304	383	299	4,4	6308

In deze houder kunnen tot vier modulekoffers opgeborgen worden.



Essve koffersysteem

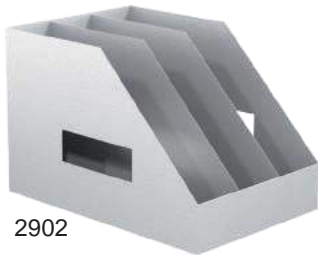

2902



2932



6754



F60001

Omschrijving

Omschrijving	Kg	Art.Nr
Legbord 470x605 mm	3,4	1704
Frame 470x670 mm	2,3	2014
Steun 470-Diepte	1,6	2310
EssBox koffer large	0,0	2312
EssBox koffer small	0,0	2313
Koffer houder voor 3 koffers	7,9	2902
Steun voor Essbox large, 1 koffer	3,2	2932
Steun voor Essbox small, 1 koffer	0,0	2933
Montage kit voor Essbox rek	0,2	5515
Plastiek mat 462x595 mm	0,4	6754
Essbox koffer rek voor 3 koffers	16,8	F60001

Legbord vergelijken

Diepte	Breedte	Hoogte	Kg	Art.Nr
300	446	65	1,9	1686

2305 en 2306. Een perfect rek voor deze populaire koffers. Deze koffers worden niet door ons verkocht. Vergelijkbare koffers van 396 x 296 (b x d) passen hier ook in.

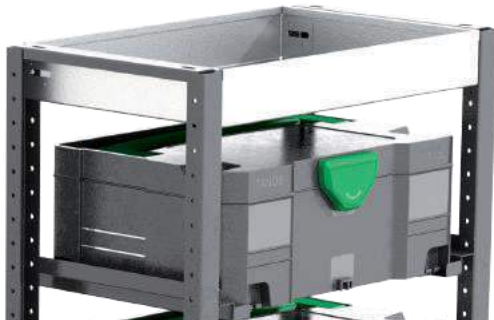



Bankvijs

Diepte	Breedte	Hoogte	Kg	Art.Nr
360	135	140	10,3	5004

De bankvijs wordt geleverd met pijpkleem en draaiplaat.
Max. Opening is 140 mm.



Bankvijs houder

Diepte	Breedte	Hoogte	Kg	Art.Nr
1110	210	195	9,4	5012
1110	210	80	5013	

De bevestigingsplaat heeft een oppervlakte van 180 x 210 mm. De cover is inbegrepen (zie hieronder).



Uitschuifbare bankvijs houder

Breedte	Hoogte	Geschikt voor	Kg	Art.Nr
1200	151	997 mm	12,4	2720
1400	151	1176 mm	14,3	2721

Past in zowel 300 en 470 mm diepe frames, kan gedraaid worden voor montage links of rechts.

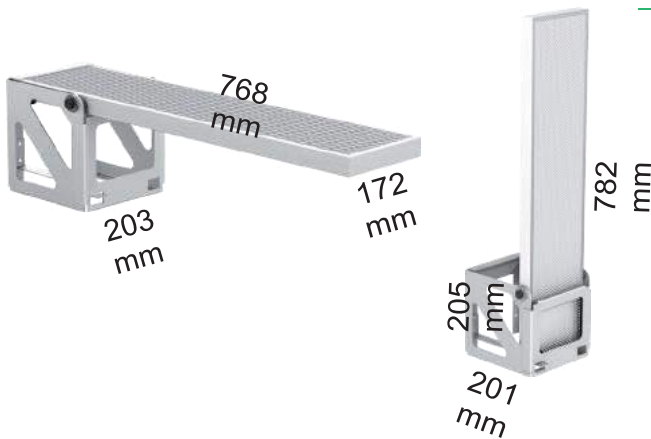

Opklapbare bankvijs houder

Kg	Art.Nr
6,0	2724



Accessoires voor bankvijs houder

Omschrijving	Kg	Art.Nr
Cover, bijgeleverd bij 5012 en 5013	1,1	2950
Steun, verstelbaar 520 – 800 mm	1,9	2952
Montageplaat, verhoog 5012 & 5013, 12 mm	0,4	5027

Steun voor 2724, 5012 of 5013.

De montageplaat is nuttig bij een oneffen oppervlak.



Gasfles houder verstelbaar

Diepte	Breedte	Hoogte	Rond Ø	Kg	Art.Nr
150	300	60	< 300	0,9	2910

De houder voor LPG P6. (Flessen van 320 mm Ø kunnen na aanpassing vastgezet worden) kan versteld worden.



Gasfles houder enkele

Diepte	Breedte	Hoogte	Rond Ø	Kg	Art.Nr
70	300	200	< 300	0,8	2912

LPG P6 (2912), Kan ook gebruikt worden voor opslag van koude media flessen.



Gasfles houder dubbele

Diepte	Breedte	Hoogte	Rond Ø	Kg	Art.Nr
95	300	200	145	1,3	2913

5kg Acetylene & zuurstof.



Gasfles houder legboard

Diepte	Breedte	Hoogte	Kg	Art.Nr
300	306	500	6,3	2914

LPG P11 of 5kg Acetylene & zuurstof. Houder voor 2 gasflessen ingebrepen.



Gasfles houder wandmontage

Diepte	Breedte	Hoogte	Rond Ø	Kg	Art.Nr
300	450	820	205	5,8	2916

Acetylene & zuurstof (AGA A21 & O20 of gelijkaardig).



Kofferklem

Diepte	Lengte	Hoogte	Kg	Art.Nr
220	1568	195	2,0	2935
-			0,6	2936

De kofferklem wordt tussen twee frames bevestigd om bvb koffers vast te zetten. Deze is 1568 mm lang en kan op maat gezaagd worden om in uw inrichting te passen. Voeg een extra haak (2936) toe voor maximale flexibiliteit, één is inbegrepen.



Slang/Kabel houder

Diepte	Breedte	Hoogte	Kg	Art.Nr
79	267	168	0,5	4077



Silicone en spuitbus houder

Diepte	Breedte	Hoogte	Kg	Art.Nr
301	300	212	1,9	4350

Kan in een legbord geplaatst worden. Of splits de twee helften en hang ze aan het perfo paneel.



Universele haak

Diepte	Breedte	Hoogte	Kg	Art.Nr
85	80	100	0,2	4356

Bevestig op een perfo paneel of aan een legbord.

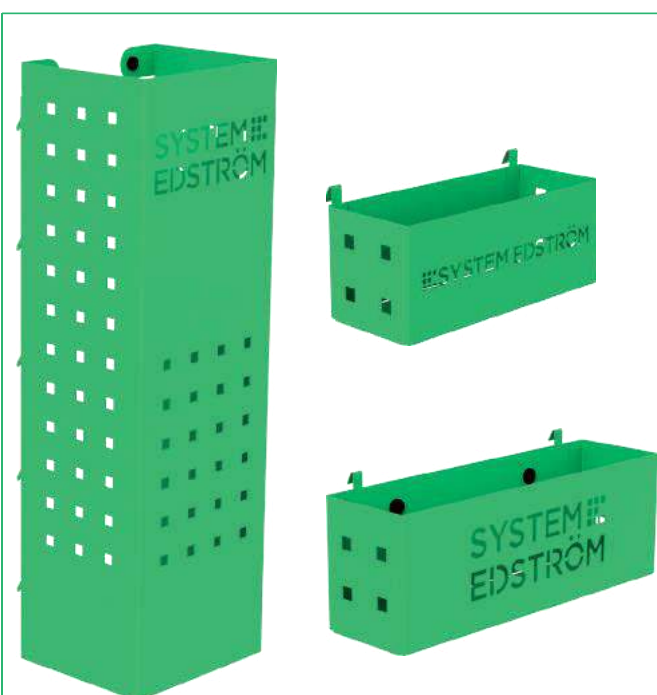

Opbergbakjes

Diepte	Breedte	Hoogte	Kg	Art.Nr
82	200	80	0,5	4360
82	285	102	0,8	4362
122	455	122	1,5	4364
153	179	575	3,0	4370



4368



5025



6308

Document houder

Diepte	Breedte	Hoogte	Kg	Art.Nr
34/69	231	210	0,6	4368
304	383	299	4,4	6308
	350	500	2,1	5025

6308 kan in een legbord geplaatst worden.

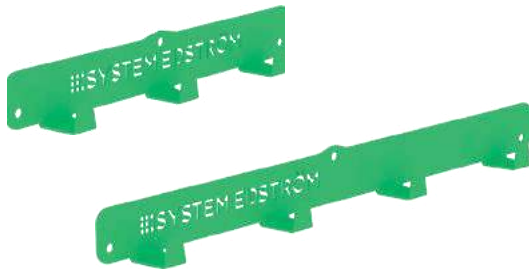

Kledinghaak

Diepte	Breedte	Hoogte	Kg	Art.Nr
31	295	40	0,3	2706
31	465	40	0,5	2708



Werkblad

Diepte	Breedte	Dikte	Kg	Art.Nr
500	900	30	9,2	6035
500	1300	30	13,4	6036
500	1700	30	16,5	6037
500	2100	30	20,5	6038
500	3000	30	30,5	6039





Enkele haak

Lengte	Ø	Art.Nr
38	5	4301
100	5	4302

Wordt verkocht per 5.



Dubbele haak

Lengte	Ø	Breedte	Art.Nr
38	5	11	4303
55	5	25	4304
100	5	25	4322

Wordt verkocht per 5.

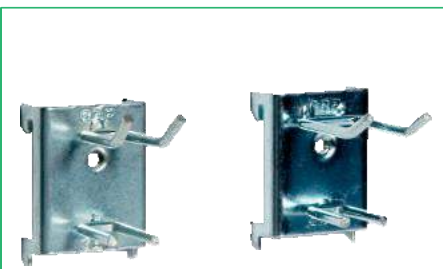

Winkelhaak dubbel

Lengte	Ø	Breedte	Art.Nr
28	3	10/9	4306
33	3	17/9	4307

Wordt verkocht per 5.

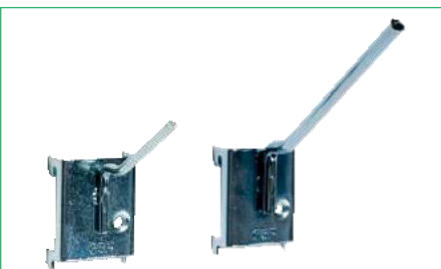

Enkele haak schuin

Lengte	Ø	Art.Nr
50	4	4308
100	6	4309

Wordt verkocht per 5.



Ronde haak

Ø	Art.Nr
60	4310
80	4311

Wordt verkocht per 5.



Gereedschap haak

Open.	Ø	Art.Nr
23/44	5	4312

Wordt verkocht per 5.



Universele haak

Hoogte	Breedte	Art.Nr
40	34	4313

Wordt verkocht per 5.



Ring haak

Ø	Art.Nr
60	4314
80	4315

Wordt verkocht per 5.

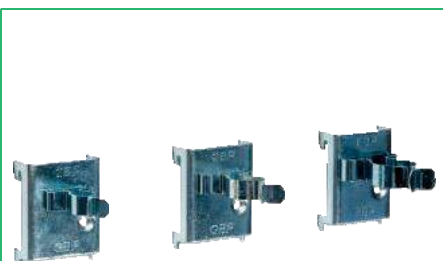

Gereedschap clips

Ø	Art.Nr
12	4316
18	4317
25	4318

Wordt verkocht per 5.



Steelklem

Ø	Art.Nr
25	4325
38	4326

Wordt verkocht per 5.



Documentklem

Breedte	Art.Nr
60	4330

Wordt verkocht per 5.



Spuitbus houder

Ø	Hoogte	Art.Nr
80	113	4353

Wordt per stuk verkocht.



Silicone en spuitbus houder

Ø	Hoogte	Art.Nr
58-70	190	4358

Wordt per stuk verkocht.



Universele klemstrip

Lengte	Hoogte	Klem.	Art.Nr
440	28	20	4354

Wordt per stuk verkocht.



Set haken

Onderdelen	Art.Nr
25	4319

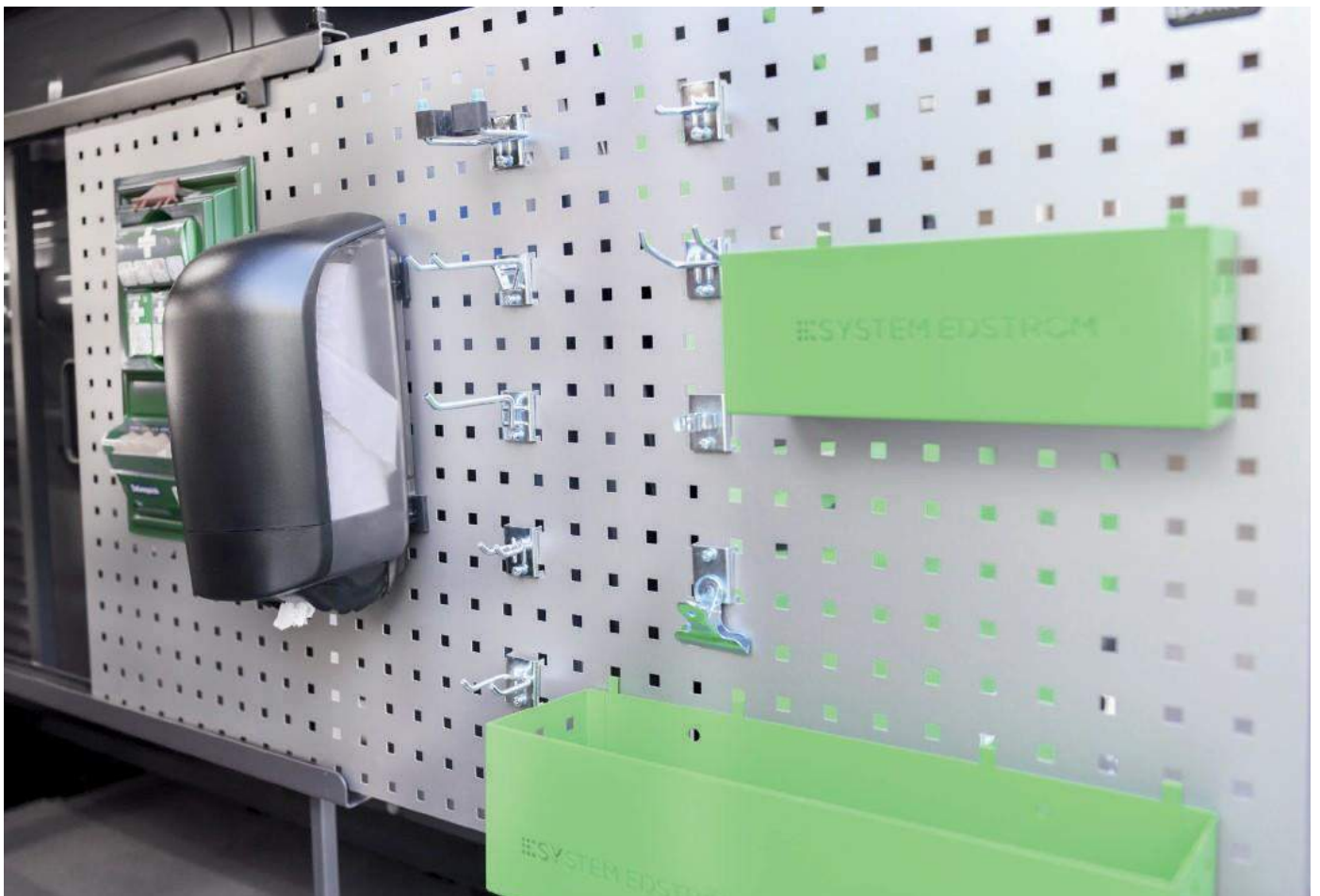

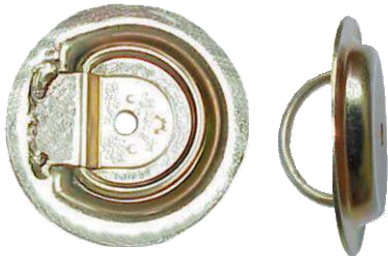

Spanoog voor inbouw

Art.Nr
5097



Spanoog

Art.Nr
5098



Spanoog voor opbouw op vloer

Art.Nr
5099



Spanband met ratelgesp

Lengte	Breedte	Art.Nr
4000	30	5107



Spanband met klemgesp 2-delig

Lengte	Breedte	Art.Nr
2520	25	5117



Spanband met klemgesp

Lengte	Breedte	Art.Nr
2500	25	5118



Spanband met klemgesp

Lengte	Breedte	Art.Nr
1200	25	4365



Rubber strap

Lengte	Art.Nr
-	Vastzetknop voor band
285	5121
Per meter	10m per pak
285	5122
	5124
	5125



Brandblusapparaten



Omschrijving	Kg	Art.Nr
2 kg, pulver		5055
4 kg, pulver		5056
6 kg, pulver		5057

Wandbevestiging is inbegrepen bij alle brandblusapparaten.

Papier dispenser



Information	Kg	Art.Nr
Magnetische bevestiging voor 5084		5083
Dispenser incl. papier		5084
Papier voor 5084		5086

Eerste-hulp



Information	Kg	Art.Nr
Eerste-hulpkit		5080
Eerste-hulpkit met reflecterende vest		5082

Vuilbakje

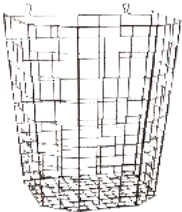

Diepte	Breedte	Hoogte	Kg	Art.Nr
235	305	350		5079

Edström kleuren



Information	Art.Nr
Antraciet grijs, spuitbus	9007
Lichgrijs, spuitbus	9014
Edström groen, spuitbus	9015



LED verlichting

Omschrijving	Lengte	Watt	Art.Nr
12/24V, 30 diodes	500	7,2	5815
12/24V, 60 diodes	1000	14,4	5816
Verlichting set LED, 2 tubes		14,4	F8320
Verlichting set LED, 3 tubes		21,6	F8321
Verlichting set LED, 4 tubes		28,8	F8322
Verlichting set LED, 5 tubes		36,0	F8323
Verlichting set LED, 6 tubes		43,2	F8324

De armaturen worden per paar geleverd. BxH 12x7 mm. 510-600 lm, 6000-7000 K. De set bestaat uit de LED units, kabels, zekering en 2 schakelaars.



5810



5811

LED verlichting

Omschrijving	Art.Nr
Opgebouwd 15mm hoog	5810
Ingebouwd - gat diameter 160 mm	5811
<ul style="list-style-type: none"> • 12/24V • 21 st SMD diodes • 420 lumen • Ingebouwde bewegingssensor • IP67 gecertificeerd 	



LED Werklamp

Omschrijving	Art.Nr
DxBxH 75x130x164 mm	5801
<ul style="list-style-type: none"> • 12/24V - 27W • 9 st 3W Cree-diodes • 1800 lumen, 6000K • Waterdichte schakelaar op achterzijde • Aan/uit schakelaar achteraan • Aluminium behuizing • IP68 gecertificeerd • Roteerbare 	



LED Werklamp

Omschrijving	Art.Nr
DxBxH 46x110x128 mm	5802
<ul style="list-style-type: none"> • 12/24V - 27W • 9 st 3W diodes • 1600 lumen • Steun in RVS • Zwart epoxy gepoederlakte aluminium behuizing • IP67 gecertificeerd 	



LED Werklamp

Omschrijving	Art.Nr
DxBxH 63x160x48 mm	5803
<ul style="list-style-type: none"> • 12V 1,4A / 24V 0,72A • 6 st diodes • 1320 lumen • Gietaluminium behuizing • IP67 gecertificeerd 	

Omvormer met zuivere sinus



Diepte	Breedte	Hoogte	Watt	Kg	Art.Nr
210	106	60	400	0,0	5430
320	170	80	1200	0,0	5431
450	166	88	2000	0,0	5432

Beschermtd tegen

- Kortsluiting
- Hoge temperatuur
- Overspanning
- Onderspanning
- Overbelasting
- Verkeerde aansluiting bij depolen

LED Flitser



Ø	Hoogte	Art.Nr
108	35	5831

- Lithium batterij CR123A 3V inbegrepen
- 16 pcs LEDs
- Kan liggend, opgehangen aan het oog , of met de magneet gebruikt worden.
- Bedrijfstemperatuur -36°C tot +116°C

Schakelaar met timer



Omschrijving	Art.Nr
12V 10/5A	5830

- Aan/uit regelbaar - 0,5 tot 6,0 uur
- Drukknop
- Montagemateriaal en montage instucties inbegrepen



Flexiplan

Breedte	Hoogte	Kg	Art.Nr
2000	1800	14,1	1370
-	1800	4,5	1371
-	-	1,1	1372

Gids voor Flexiplan

Secties	Maximum lengte	Artikels
1	2000	1 x 1370
2	2000	1 x 1370 + 1 x 1371
3	3000	2 x 1370
4	4000	2 x 1370

Legborden en montagekits (1372) moeten apart toegevoegd worden, één 1372 per legbord. Bekijk de legborden op pagina 6, maximum lengte 1568 mm wordt aangeraden.

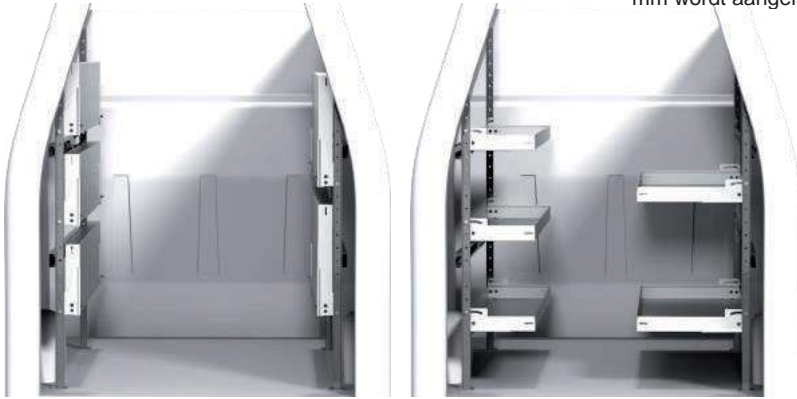

Tubo buizenlader



Lengte	Breedte	Hoogte	Kg	Art.Nr
3050	125	125	14,0	8467

Onze buizenlader heeft een systeem om eenvoudig aan uw lading te kunnen.

Interne ladder houder



Lengte	Kg	Art.Nr
2400	5,2	T8900

Hang uw ladder op tegen het dak en met een simpele beweging kan de ladder naar de achterdeur toe getrokken worden.



Legbord steunen

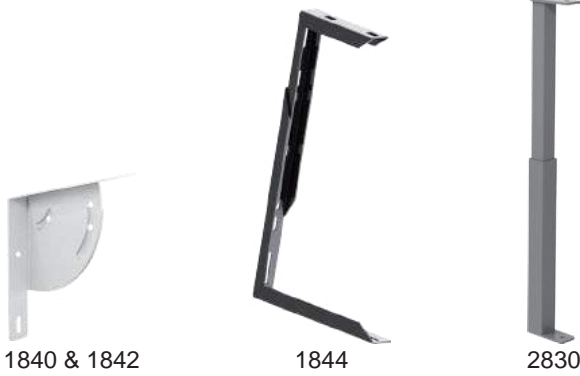

Diepte	Hoogte	Kg	Art.Nr
160		0,3	1840
300		0,5	1842
	260-410 mm	0,9	1844
	235-410 mm	0,6	2830

X-verbinding



Kg	Art.Nr
0,8	2850

De X-verbinding past op alle maten van lange schuiven en frames groter dan 505 mm. Het kan ook gebruikt worden in combinatie met onze standaard legborden tot 1176 mm.

Montage rails

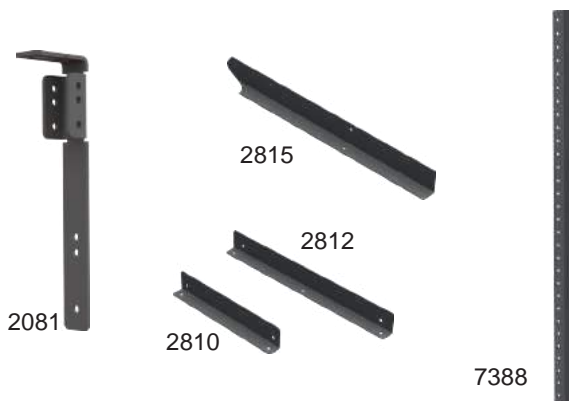

Lengte	Afmetingen	Kg	Art.Nr
200	26 x 54	0,3	2081
295	50 x 30	0,3	2810
460	50 x 30	0,5	2812
2000	50 x 30 (5-pack)	12,3	2816
1568	50 x 30	2,0	2817
		0,9	7388







2081 is ontworpen om 2 frames op elkaar te plaatsen in de hoogte.



L-profiel















Lengte	Afmetingen	Kg	Art.Nr
784	50 x 30	1,1	2820
907	50 x 30	1,2	2822
997	50 x 30	1,4	2824
1176	50 x 30	1,6	2826
1389	50 x 30	1,6	2828
1568	50 x 30	1,7	2829

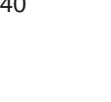

		Montagebeugels		
		Breedte	Afmetingen	Art.Nr
	2809	53	58 x 58	2801
	2811	53	58 x 112	2803
	2801	53	58 x 154	2805
	2803	53	58 x 209	2807
	2805	53	58 x 264	2808
	2807	53	80:87:80	2809
	2808	53	58:64:58	2811

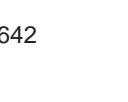
		Montageset		
		Informatie	Onderdelen	Art.Nr
		Montageset, klein	146	5501
		Montageset, normaal	238	5502
		Montageset, Voor bankvijs en bankvijs houder	57	5510
				T5310

		Schroef en Moer	
		Ø	Lengte
	M6	M6	10
	M8	M6	12
	5600	M6	16
	5620	M6	20
		M6	25
		M6	30
		M6	35
		M6	50
		M6	Moer
	5640	M6	Ø 22
	5642	M8	16
		M8	20
		M8	30
		M8	35
		M8	40
		M8	50
		M8	60
		M8	Moer
		M8	Ø 28

		Blindklinknagels		
		Ø	Lengte	
	5662	4,8	10	Staal
	5672	4,8	10	Alu
		4,8	14	Staal
		4,8	21	Staal
		4,8	30	Staal
		6,4	15	Staal
		6,4	18	Staal
		6,4	22	Staal
		6,4	30	Staal
		6,4	40	Alu/Staal

INFORMATIE



ALGEMEEN

System Edström Bininredningar AB is gecertificeerd volgens SS-EN ISO 9001:2015 om onze administratieve kwaliteit te waarborgen en accurate leveringen te garanderen.

Alle materialen die in System Edström gebruikt worden, kunnen tot 100% gerecycleerd worden.

Wij zijn gecertificeerd volgens SS-EN ISO 14001:2015



ONTHOUD

Uw keuze voor System Edström is uw eerste stap naar een functionele en veilige mobiele werkplaats.

Onthoud;
U hebt als chauffeur volle verantwoordelijkheid wanneer uzelf of iemand gewond geraakt door slecht gezeekerde lading.

Zorg ervoor dat u nooit het maximum laadvermogen van het voertuig overschrijdt!



VEILIGHEID

Onze producten zijn getest op 2 manieren. De eerste en belangrijkste manier zijn twee crashtesten: één (ECE 17:07) uitgevoerd door Milbrook in Engeland en de tweede door Valutec in Frankrijk (INRS NS286).

Meer info hierover op onze homepagina www.systemedstrom.com



Inhoudstabel

Accessoires voor bankvijs houder	16	Montageset	28
Afstandbus	9	Neerklapbaar front	8
Bankvijs	16	Neerklapbare front	7
Bankvijs houder	16	Omvormer met zuivere sinus	25
Blindklinknagels	28	Opbergbakjes	18
Bovenplaten	5	Opberg box	13
Brandblusapparaten	23	Opklapbare bankvijs houder	16
Chassis van uitschuifbaar platform	12	Papier dispenser	23
Document houder	19	Perfopanelen - randen omgezet	9
Documentklem	20	Perfopanelen - vlakke plaat	9
Dubbele haak	20	Plastieken sorteerbakken	11
Edström kleuren	23	Ring haak	20
Eerste-hulp	23	Ronde haak	20
Enkele haak	20	Rubber mat	10
Enkele haak	20	Rubber mat voor uitschuifbare legborden	10
Enkele haak schuin	20	Rubber strap	22
Essve koffersysteem	15	Schakelaar met timer	25
Flexiplan	26	Schroef en Moer	28
Frame	4	Set haken	21
Frame opzetstuk	4	Silicone en spuitbus houder	18
Frame voor valse vloer en uitschuifbare legborden	4	Silicone en spuitbus houder	21
Gasfles houder dubbele	17	Slang/Kabel houder	18
Gasfles houder enkele	17	Sokkels	5
Gasfles houder legboard	17	Spanband met klemgesp	22
Gasfles houder verstelbaar	17	Spanband met klemgesp	22
Gasfles houder wandmontage	17	Spanband met klemgesp 2-delig	22
Gasfles kasten	13	Spanband met ratelgesp	22
Gereedschap clips	20	Spanoog	22
Gereedschapscompartiment	13	Spanoog voor inbouw	22
Gereedschap haak	20	Spanoog voor opbouw op vloer	22
Interne ladder houder	26	Spuitbus houder	21
Kasten	13	Steelklem	20
Kledinghaak	19	Tubo buizenlader	26
Koffer	14	Tussenschotten	7
Koffer compartiment	14	Tussenschotten voor uitschuifbare legborden	6
Koffer/Document houder	14	Tussenschot voor legbord met open voorzijde	8
Kofferindeling	14	Uitschuifbaar frame	12
Kofferklem	18	Uitschuifbaar perfo paneel	9
Lade mousse	6	Uitschuifbare bankvijs houder	16
Laden	5	Uitschuifbare laadvloer	12
LED Flitser	25	Uitschuifbare legborden	6
LED verlichting	24	Universele haak	18
LED Werklamp	24	Universele haak	20
LED Werklamp	24	Universele klemstrip	21
LED Werklamp	24	Vaste steun voor koffer	14
Legborden	7	Vaste steun voor koffer	14
Legbord met open voorzijde	8	Verdeelbakjes voor in laden	6
Legbord steunen	27	Verstelbaar frame	12
Legbordverbinder	7	Voetsteun voor frame	4
Legbord vergelijken	15	Vuilbakje	23
Legbord voor kabelrollen	8	Werkblad	19
L-profiel	27	Wielbakkasten	13
Montagebeugels	28	Winkelhaak dubbel	20
Montage rails	27	X-verbinding	27



